

GIA NATURAL COLORED DIAMOND REPORT

September 30, 2022

Report Type ..... Grading Report

GIA Report Number ..... 2225643288

Shape and Cutting Style ..... Oval Modified Brilliant

Measurements ..... 6.49 x 4.99 x 3.37 mm

Carat Weight ..... 0.89 carat

Color Grade ..... Fancy Brownish Yellow

Color Origin ..... Natural

Color Distribution ..... Even

Clarity Grade ..... VS2

Proportions:

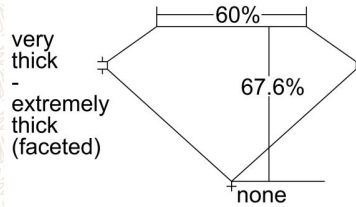

Profile not to actual proportions

Polish ..... Good

Symmetry ..... Good

Fluorescence ..... None

Inscription(s): GIA 2225643288

Comments: Clouds are not shown. Additional pinpoint are not shown.

ADDITIONAL INFORMATION

GIA COLORED DIAMOND SCALE

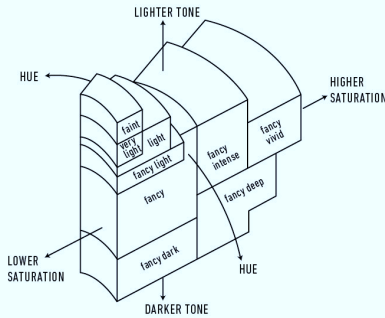
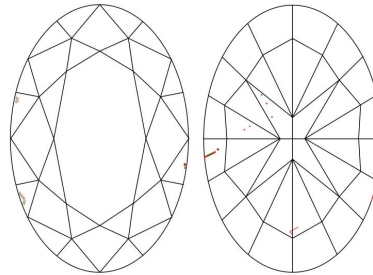

Illustration of GIA fancy color grade interrelationships





GIA CLARITY SCALE

FLAWLESS
INTERNALLY FLAWLESS
VVS <sub>1</sub>
VVS <sub>2</sub>
VS <sub>1</sub>
VS <sub>2</sub>
SI <sub>1</sub>
SI <sub>2</sub>
I <sub>1</sub>
I <sub>2</sub>
I <sub>3</sub>

CLARITY CHARACTERISTICS



KEY TO SYMBOLS\*

-  Feather
-  Etch Channel
-  Indented Natural
-  Pinpoint

\* Red symbols denote internal characteristics (inclusions). Green or black symbols denote external characteristics (blemishes). Diagram is an approximate representation of the diamond, and symbols shown indicate type, position, and approximate size of clarity characteristics. All clarity characteristics may not be shown. Details of finish are not shown.



reportcheck.gia.edu



The results documented in this report refer only to the diamond described, and were obtained using the techniques and equipment available to GIA at the time of examination. This report is not a guarantee or valuation. For additional information and important limitations and disclaimers, please see GIA.edu/terms or call +1 800 421 7250 or +1 760 603 4500. ©2022 Gemological Institute of America, Inc.

 THE SECURITY FEATURES IN THIS DOCUMENT, INCLUDING THE HOLOGRAM, SECURITY SCREEN AND MICROPRINT LINES, IN ADDITION TO THOSE NOT LISTED, EXCEED DOCUMENT SECURITY INDUSTRY GUIDELINES.