

GIA NATURAL COLORED DIAMOND REPORT

September 09, 2024
 Report Type Grading Report
 GIA Report Number 6505239178
 Shape and Cutting Style Cut-Cornered Rectangular
 Modified Brilliant
 Measurements 7.40 x 6.16 x 4.45 mm

Carat Weight 2.01 carat
 Color Grade Fancy Light Yellow
 Color Origin Natural
 Color Distribution Even
 Clarity Grade VS2
 Proportions:

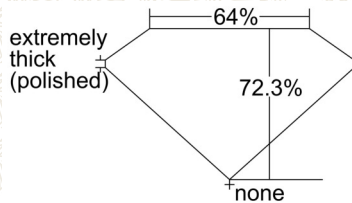

Profile not to actual proportions

Polish Excellent
 Symmetry Good
 Fluorescence None
 Inscription(s): GIA 6505239178

ADDITIONAL INFORMATION
GIA COLORED DIAMOND SCALE





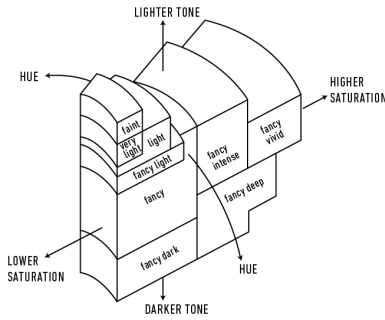
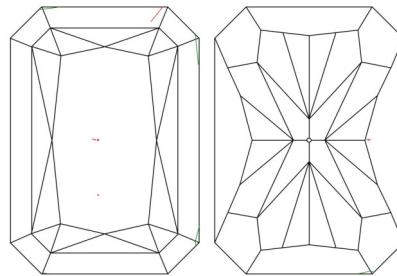

Illustration of GIA fancy color grade interrelationships

GIA CLARITY SCALE

FLAWLESS
INTERNALLY FLAWLESS
VVS ₁
VVS ₂
VS ₁
VS ₂
SI ₁
SI ₂
I ₁
I ₂
I ₃

VERY VERY SLIGHTLY INCLUDED
VERY SLIGHTLY INCLUDED
SLIGHTLY INCLUDED
INCLUDED

CLARITY CHARACTERISTICS

KEY TO SYMBOLS*

-  Feather
-  Crystal
-  Pinpoint
-  Cloud
-  Natural

* Red symbols denote internal characteristics (inclusions). Green or black symbols denote external characteristics (blemishes). Diagram is an approximate representation of the diamond, and symbols shown indicate type, position, and approximate size of clarity characteristics. All clarity characteristics may not be shown. Details of finish are not shown.

reportcheck.gia.edu

The results documented in this report refer only to the diamond described, and were obtained using the techniques and equipment available to GIA at the time of examination. This report is not a guarantee or valuation. For additional information and important limitations and disclaimers, please see GIA.edu/terms or call +1 800 421 7250 or +1 760 603 4500. ©2023 Gemological Institute of America, Inc.

 THE SECURITY FEATURES IN THIS DOCUMENT, INCLUDING THE HOLOGRAM, SECURITY SCREEN AND MICROPRINT LINES, IN ADDITION TO THOSE NOT LISTED, EXCEED DOCUMENT SECURITY INDUSTRY GUIDELINES.